

NEWWORLD

Vision

**E60Fa**

60cm Fanned Electric Oven / Grill

user • installation • instructions

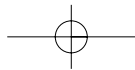
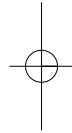
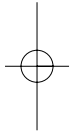

# Contents

---

<b>User's Section</b> . . . . .	<b>2 - 22</b>
Introduction . . . . .	2
Be Safe - Not Sorry . . . . .	4
Using the Grill . . . . .	5
Using the Oven . . . . .	7
Cooking with a fan oven . . . . .	8
Slow cooking . . . . .	9
Cooking frozen & chilled foods . . . . .	9
Defrosting and cooling . . . . .	10
Baking guide . . . . .	11
Traditional fruit cakes . . . . .	12
Roast turkey . . . . .	12
Roasting guide . . . . .	13
Automatic cooking . . . . .	14
Programmer / Clock . . . . .	16
Cleaning . . . . .	20
<b>Installation Instructions</b> . . . . .	<b>23 - 26</b>
Step 1: Prepare installation . . . . .	23
Step 2: Connect to electricity supply . . . . .	25
Step 3: Check edging strip . . . . .	26
Step 4: Secure appliance into housing unit . . . . .	26
<b>Technical Data</b> . . . . .	<b>27</b>
<b>New World Customer Care</b> . . . . .	<b>28</b>

*Please keep this handbook for future reference, or for anyone else who may use the appliance.*

## Introduction

---

### Thank you for choosing a New World appliance

We hope that the following information will help you to familiarise yourself with the features of the appliance, and to use it successfully and safely.

Our policy is one of constant development and improvement. Strict accuracy of illustrations and specifications is not guaranteed. Modification to design and materials may be necessary subsequent to publication.

Please read the instructions in this handbook before using or installing this appliance.

### **Your 1st Year Guarantee**

To fulfil the conditions of your guarantee, this appliance must be correctly installed and operated, in accordance with these instructions, and only be used for normal domestic purposes.

Please note that the guarantee, and Service availability, only apply to the UK and Republic of Ireland.

**Before using the appliance** for the first time, remove any protective polythene film and wash the oven shelves and furniture in hot soapy water to remove their protective covering of oil. Even so, when you first switch on the oven or grill you may notice a smell and some smoke.

This appliance is designed to fit into a standard 600mm wide housing unit with a minimum internal height of 580mm.

### **Electrical connection**

Please refer to installation instructions for electrical connection.

In your own interest, and that of safety, make sure that the installation is carried out by a competent person.

Disconnection of electric appliances should always be carried out by a competent person.

**Warning:** This appliance must be earthed.

### **Condensation**

When hot and cold air meet, condensation forms. The outer door is air cooled and the inner door gets hot, so some condensation might form; this is normal and will disappear within 10 - 15 minutes.

## Introduction

---

### Cooling fan

The cooling fan helps to keep the exterior cool during normal use. When an element is operated, you should hear the cooling fan switch on automatically and be able to feel air evacuating from the appliance vents just below the fascia.

The cooling fan will continue to operate for approximately 10 minutes after turning off the elements. This is normal.

If there is no such indication that the fan is operating, the appliance will require servicing. **DO NOT USE THE APPLIANCE UNTIL IT HAS BEEN SERVICED.** Switch the appliance off at the mains and contact Customer Support.

### Glass door panels

To meet the relevant standards of Domestic cooking appliances, all the glass panels on this appliance are toughened to meet the fragmentation requirements of BS 3193. This ensures that, in the unlikely event that a panel breaks, it does so into small fragments to minimise the risk of injury.

Please take care when handling, using or cleaning all glass panels as any damage to the surfaces or edges may result in the glass breaking without warning or apparent cause at a later date. Should any glass panel be damaged, we strongly recommend that it is replaced immediately.

### To replace an oven light bulb (if fitted)

**Caution:** Switch off the electricity supply to the appliance, to avoid the risk of electric shock.

Wait until the oven is cool, then remove the oven shelves.

Remove the loose oven back - unscrew the 4 securing screws (one at each corner). Unscrew the lens cover (turn anticlockwise). Unscrew the bulb and replace. Replace lens cover, and replace oven back.

Please note that the oven light bulb is not covered by the guarantee.

### Environmental Protection

Stoves Limited is committed to protecting the environment and operates an Environmental Management System which complies with BS EN ISO 14001:1996.

### Disposal of packaging

- All our packaging materials are recyclable and environmentally friendly.
- Please help us to protect our environment by disposing of all packaging in an environmentally friendly manner.
- Please contact your local authority for the nearest recycling centre.

**Caution:** Packaging materials can pose a risk of suffocation - keep away from children.

## Be Safe - Not Sorry

### **When you are cooking, keep children away from the vicinity of appliance.**

This product is designed as a domestic cooking appliance for the preparation and cooking of domestic food products, and should not be used for any other purpose.

- Remove all packaging from the appliance before using for the first time.
- Make sure you read and understand the instructions before using the appliance.
- Keep electrical leads short so they do not drape over the appliance or the edge of the worktop.
- Keep all flammable materials (such as curtains, furnishings & clothing) away from the appliance.
- Parts of the appliance may be hot during or immediately after use. Care should be taken to avoid touching heating elements inside the oven. Allow sufficient time for the appliance to cool after switching off.
- Switch off the electricity supply before cleaning the appliance.
- Do not drape tea towels over the flue vents as this creates a fire hazard.
- When opening the appliance door, take care to avoid skin contact with any steam which may escape from the cooking.

- Using aluminium foil to cover the grill pan, or putting items wrapped in foil under the grill creates a fire hazard. The high reflectivity can also damage the element.
- Do not use foil on oven shelves or on the oven base, or allow it to block the oven flue, as this creates a fire hazard and prevents heat circulation.
- Do not use the oven with the door inner glass panel removed.
- Use oven gloves when removing hot food / dishes from the oven or grill. The oven / grill and utensils will be very hot when in use.
- When cooking heavy items - eg; turkeys - do not pull the oven shelf out with the item still on the shelf.
- Switch off the electricity supply before replacing the oven light bulb (if fitted), to avoid the risk of electric shock.
- Never use the appliance for heating a room.
- **Warning:** This appliance must be earthed.

All installation, servicing and maintenance work should be carried out by a competent person who will comply with current Regulations, Standards and Requirements.

**When you have finished cooking check that all controls are in the off position.**

## Using the Grill

**Caution: Accessible parts may be hot when the grill is used, young children should be kept away.**

The grill is a single circuit fully variable grill. It can be used for conventional grilling, or as a fanned grill.

### To switch on the grill

Turn the function selector control knob to either the ☺ conventional grill symbol, or the ☹ fanned grill symbol.

Turn the temperature selector control knob clockwise to the desired grill temperature setting.

To switch off the oven, return the control knob to the "●" off position.

### **Preheating**

For best results, preheat the grill for 3 - 5 minutes.

### **Aluminium foil**

Using aluminium foil to cover the grill pan, or putting items wrapped in foil under the grill, can create a fire hazard, and the high reflectivity can damage the grill element.

### **Detachable grill pan handle**

Place the handle over the edge of the grill pan. The handle should be removed from the pan during grilling, to prevent overheating.

The handle is designed for removing / inserting the grill pan under the grill when grilling.

If cleaning the grill pan when it is hot, use oven gloves to move it. *Do not* use the handle to pour hot fats from the grill pan.

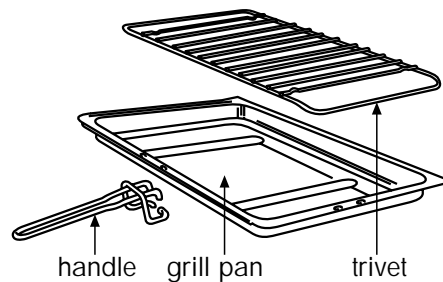

### **Grill pan trivet**

Food for grilling should be placed within the area defined by the kinks in the trivet wires.

## Using the Grill

---

### **Conventional grill**

The door must be open when the conventional grill function is used - either fully open or using the door stop position - open the door about 30° and it will hold open.

When using the door stop position for grilling, you can remove the grill pan handle by sliding it to the recess.

Thicker foods such as sausages and chicken portions are suited to conventional grilling.

### **Fanned grill**

The door must be **closed** when the fanned grill is used.

When opening the door, take care to avoid skin contact with any steam which may escape from the cooking.

Fanned grilling may be faster than conventional grilling, because air is being circulated around the food, and thin portions of food such as bacon or fish fillets may not need turning.

The fanned grill is particularly suited to thinner foods such as bacon, gammon, fish fillets etc.

### **Grilling**

The temperature of the grill is variable, and can be adjusted by turning the temperature selector control knob to the desired temperature setting.

We recommend that the higher temperature settings are used for toasting and for cooking foods such as bacon, sausages or steaks. For thicker foods such as chops or chicken joint pieces, the temperature may be reduced to a lower setting.

Position the grill pan under the centre of the grill.

The grill pan trivet, inside the grill pan, can be inverted to give a high or low position, or it may be removed.



## Using the Oven

---

**When you are cooking, keep children away from the vicinity of the oven.**

The oven in your E60Fa is a Gyrofan fanned electric oven.

### To switch on the oven

Turn the function selector control knob to the  fan oven symbol.

Turn the temperature selector control knob clockwise to the desired temperature setting.

The red thermostat indicator will come on until the selected temperature is reached and then go off; it will turn on and off periodically as the thermostat operates to maintain the selected temperature.

*To switch off*, return the control knob to the "●" off position.

### Preheating

The oven must be preheated when cooking frozen or chilled food, and we recommend preheating for yeast mixtures, batters, soufflés and whisked sponges, otherwise preheating is not necessary as a fan oven warms up quickly.

Preheat the oven until the indicator light switches off for the first time; this will take between 5 - 15 minutes, depending on the temperature selected.

### Aluminium foil

Use aluminium foil only to cover food or cooking dishes. Do not foil to cover the shelves or oven base, as this creates a fire hazard.

### Baking tray and roasting tins

For best cooked results and even browning, the maximum size baking trays and roasting tins that should be used are as follows;

Baking tray 350mm x 280mm

This size of baking tray will hold up to 20 small cakes.

Roasting tin 370mm x 320mm

We recommend that you use good quality cookware. Poor quality trays and tins may warp when heated, leading to uneven baking results.

### Oven shelves

The oven shelf must be positioned with the upstand at the rear of the oven and facing upwards.

Position baking trays and roasting tins on the middle of the shelves, and leave one clear shelf position between shelves, to allow for circulation of heat.

## Using the Oven

---

### **Cooking with a fan oven**

If you are used to cooking with a conventional oven you will find a number of differences to cooking with a fan oven which will require a different approach:

There are no zones of heat in a fan oven, the convection fan at the back of the oven ensures an even temperature throughout the oven; this makes it ideal for batch baking - eg; when planning a party or stocking the freezer, as all the items will be cooked within the same length of time.

Cooking times will generally be shorter by between 5 - 10 minutes per hour, than those given in recipe books for conventional cooking.

We recommend preheating the oven for frozen or chilled food and also for soufflés, batter mixtures & yeast mixtures. Preheat the oven until the indicator light switches off for the first time; this will take between 5 - 15 minutes depending on the temperature selected.

There is no flavour transference in a fan oven, which means you can cook strong smelling foods such as fish at the same time as mild foods - eg; milk puddings.

The fan oven may cook foods at a lower temperature (between 10°C and 20°C lower) than a conventional oven, so conventional recipe temperature may have to be reduced.

### **To help the air circulate freely;**

- Position the shelves evenly within the oven and maintain a clearance from the oven roof and base.
- If more than one cooking dish or baking tray is to be used on a shelf leave a gap of at least 25mm / 1" between the items themselves and the oven interior.
- Allow enough space between shelves for food that will rise during cooking.
- Do not place items on the oven base as this will prevent air from circulating freely.

## Using the Oven

---

### **Slow cooking**

- For roasting joints of meat or poultry and for pot roasts preheat the oven to 190°C - 200°C and cook for 30 minutes, then adjust the oven control to the 110 - 120°C "slow setting" for the remainder of the cooking time.
- Slow cooking times will be about 3 times as long as conventional cooking times.
- Make sure that frozen foods are thoroughly THAWED before cooking.
- Do not slow cook joints of meat or poultry weighing more than 2¼kg / 4½lb.

### **Cooking frozen & chilled foods**

- Always preheat the oven before use.
- When cooking frozen or chilled foods, please follow the food manufacturer's instructions. If cooking more than one tray or item, cooking times may need to be increased.
- Please ensure that foods are piping hot before consumption.
- Always use the temperature setting stated on the food packaging when cooking convenience food.
- Never overload the tray - eg; oven chips should be placed on the baking tray in one even layer for satisfactory cooking.
- Follow the cooking times given on the packaging, but remember that they are only intended as a guide, and do not take individual preferences into account.
- Always cook frozen convenience foods straight from the freezer unless packaging advises otherwise.

## Using the Oven

---

### **Defrosting and cooling**

To **defrost** frozen foods, turn the oven control to the  defrost position, place the food in the centre of the oven and close the door.

To **cool** foods after cooking prior to refrigerating or freezing, turn the oven control to the  defrost position, and open the door about 30° to the stop position.

### **Be Safe**

- Do not defrost stuffed poultry using this method.
- Do not defrost larger joints of meat and poultry over 2kg/4lb using this method.
- Never place uncooked food for defrosting next to cooked food which is to be cooled, as this can lead to cross contamination.
- Defrosting meat, poultry and fish can be accelerated using this method but make sure they are completely thawed before cooking thoroughly. Place meat and poultry on a trivet in a meat tin.

### **Defrosting times**

Small or thin pieces of frozen fish or meat eg; fish fillets, prawns and mince will take approximately 1 - 2 hours. Placing the food in a single layer will reduce the thawing time.

A medium sized casserole or stew will take approximately 3 - 4 hours.

A 1½kg/3lb oven ready chicken will take approximately 5 hours, remove the giblets as soon as possible.

## Using the Oven

### **Baking guide**

Because a fan oven has an even temperature throughout the oven, no shelf positions have been given.

The cooking times are only approximate because the size and type of cooking dish will influence cooking time as will personal preferences.

<b>Item</b>	<b>Temperature at °C</b>	<b>Approximate cooking time</b>
Small cakes	170 - 180	20 - 25 mins
Whisked Sponge	170	15 - 20 mins
Swiss Roll	190	8 - 12 mins
Victoria Sandwich (2 x 205mm / 8 in)	160	25 - 35 mins
Semi rich fruit cake (230mm / 9 in)	140	2½ - 3½ hours
Scones	210 - 220	10 - 15 mins
Meringues	90 - 100	2 - 3 hours
Shortcrust Pastry	200	Depend on the size & type of cooking dish and also the filling.
Puff / Pastry	210	
Choux Pastry	200	
Biscuits	160 - 200	10 - 20 mins
Bread (500g / 1 lb)	210	20 - 30 mins
Sponge Pudding	150	45 mins - 1 hour
Milk Pudding	150	1½ - 1¾ hours

## Using the Oven

---

### Traditional fruit cakes

It should be remembered that ovens can vary over time, therefore cooking times can vary, making it difficult to be precise when baking fruit cakes.

It is necessary, therefore, to test the cake before removal from the oven. Use a fine warmed skewer inserted into the centre of the cake. If the skewer comes out clean, then the cake is cooked.

- Do not attempt to make Christmas cakes larger than the oven can cope with; you should allow at least 25mm (1 inch) space between the oven walls and the tin.
- Always follow the temperatures recommended in the **recipe**.
- To protect a very rich fruit cake during cooking, tie 2 layers of brown paper around the tin.
- We recommend that the cake tin is not stood on layers of brown paper, as this can hinder effective circulation of air.
- Do not use soft tub margarine for rich fruit cakes unless specified in the recipe.
- Always use the correct size and shape of tin for the recipe quantities.

### Roast turkey

Roasting turkey perfectly involves cooking two different types of meat - the delicate light breast meat, which must not be allowed to dry out, and the darker leg meat, which takes longer to cook.

The turkey must be roasted long enough for the legs to cook, so frequent basting is necessary. The breast meat can be covered once browned.

- Turkey should be roasted at 170 - 190°C for 20 minutes per 1lb, plus 20 minutes unless packaging advises otherwise.
- The turkey can be open roasted, breast side down, for half of the cook time, and then turned over for the remainder of the cooking time.
- If the turkey is stuffed, **add** 5 minutes per 1lb to the cooking time.
- If roasting turkey covered with foil, **add** 5 minutes per 1lb to the cooking time.

To test if the turkey is cooked, push a fine skewer into the thickest part of the thigh. If the juices run clear, the turkey is cooked. If the juices are still pink, the turkey will need longer cooking.

## Using the Oven

### Roasting guide

The times given in the roasting guide are only approximate, because the size and age of the bird will influence cooking times as will the shape of a joint and the proportion of bone.

Frozen meat should be thoroughly thawed before cooking. For large joints it is advisable to thaw overnight.

Frozen poultry should be thoroughly thawed before cooking. The time required depends on the size of the bird - eg; a large turkey may take up to 48 hours to thaw.

Use of a trivet with a roasting tin will reduce fat splashing and will help to keep the oven interior clean. Alternatively, to help reduce fat splashing, potatoes or other vegetables can be roasted around the meat / poultry.

### **Notes;**

- When cooking stuffed meat or poultry, calculate the cooking time from the total weight of the meat plus the stuffing.
- For joints cooked in foil or covered roasters, and for lidded casseroles, add 5 minutes per 450g (1lb) to the calculated cooking time.
- Smaller joints weighing less than 1.25kg (2½lb) may require 5 minutes per 450g (1lb) extra cooking time.
- Position the oven shelf so that the meat or poultry will be in the centre of the oven.
- It is recommended that the appliance is cleaned after open roasting.

Cook in oven at 180°C		Approximate cooking time (preheated oven)
<b>Beef</b>	Rare	20 minutes per 450g (1lb), plus 20 minutes
	Medium	25 minutes per 450g (1lb), plus 20 minutes
	Well done	30 minutes per 450g (1lb), plus 30 minutes
<b>Lamb</b>	Medium	25 minutes per 450g (1lb), plus 25 minutes
	Well done	30 minutes per 450g (1lb), plus 30 minutes
<b>Pork</b>		35 minutes per 450g (1lb), plus 35 minutes
<b>Poultry</b>		20 minutes per 450g (1lb), plus 20 minutes

## Using the Oven

---

### **Automatic cooking**

The automatic cooking facility is controlled by the programmer (see 'Programmer/ Clock' section) and allows complete meals, or individual dishes to be cooked while you are out of the house, to be ready for when you return. The '*Ready Time*' should be set as close as possible to, or just after your anticipated return so food is not left standing in a warm oven.

### **Do:**

- Select foods which are as fresh as possible, and as cold as possible - ie; preferably straight from the refrigerator.
- Choose foods which are suitable for cooking from a cold start, as some dishes will be affected by being left uncooked, at room temperature, perhaps for several hours - eg; a wet filling on a pastry base.
- Make sure that meat and poultry are thoroughly thawed (but still cold from the refrigerator), before placing them in the oven, and avoid using rolled joints of meat which can be more susceptible to the growth of food poisoning organisms.
- Cover dishes with lids or foil to keep the food moist, prevent the transfer of odours, and protect from possible contamination; the food can be uncovered towards the end of cooking to crisp and brown.

### **Do not:**

- Warm food should never be placed in the oven if there is a delay period. Stews prepared by frying the meat and vegetables first should be cooked as soon as possible, or refrigerated prior to placing in the oven.
- Some dishes are not suitable for cooking on automatic - eg; dishes containing left over cooked meat or poultry, eggs, cooked rice or seafood.
- Do not put food items (intended for automatic cooking) into a warm oven. Allow the oven to cool before setting for automatic cooking.
- Do not over-fill dishes containing liquids as they might boil over.
- Never leave food in the oven to cool slowly after cooking; serve immediately or refrigerated.
- Never use the automatic facility to reheat 'cook chill' foods as they should go straight from the refrigerator into a preheated oven.



## Using the Oven

---

**Important:** Food is more susceptible to the growth of food poisoning organisms in warm conditions. If the weather is hot, either take care to ensure that food is not left standing in a warm oven, or avoid using the automatic cooking facility.

### Hints for automatic cooking

- Food is placed in a cold oven so you will need to add about 10 - 15 minutes onto the cooking time to allow for the oven to reach the selected temperature.
- Wine or beer may ferment, and cream may curdle during the delay period, so it is best to add these ingredients just before serving.
- Potatoes should be parboiled or brushed with oil to prevent discolouration during the delay period.
- Meat can be brushed with oil to prevent it drying.
- Lemon juice can be added to certain fruits and vegetables such as apples, pears, turnips and parsnips to prevent discolouration during the delay period.

## Programmer / Clock

### The programmer buttons

- 🕒 minute minder
- 🕒 cook time
- 🕒 ready time
- 🕒 manual
- minus
- + plus

### To set the time of day

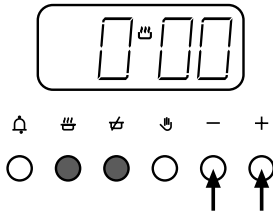

Press the *cook time* and *ready time* buttons simultaneously, and keep them depressed. Use the *plus* and *minus* buttons to set the required time.

Auto symbol goes out. The cookpot symbol comes on.

### To select an alarm tone

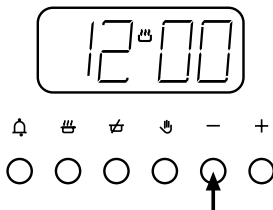

Press the *minus* button to listen to the first tone.

Release the *minus* button and press it again to listen to the second tone etc.

Releasing the *minus* button after the tone has sounded will automatically select that tone.

### Manual operation

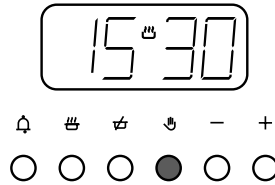

To set the programmer to manual operation at any time (cancelling any automatic setting), press the *manual* button. The programmer **must** be set to manual before the appliance can be used manually.

### Setting the minute minder

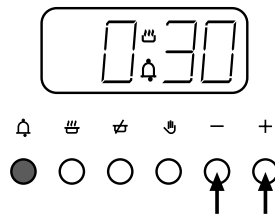

Press the *minute minder* button, then use the *plus* and *minus* buttons to set the required time.

The minute minder symbol will appear on the display.

You can cancel the minute minder at any time by pressing the *minute minder* button and the *minus* button until the display returns to 0.00.

After setting, the display will revert to show the time of day, but you can press the *minute minder* button and the display will show the minutes remaining.

The tone will sound at the end of the time set - to cancel the tone, press the minute minder button.

## Programmer / Clock

### Semi-automatic cooking (example)

You have started cooking a meal or dish in the oven, and want to set the time for the oven to switch off.

Press the *cook time* button, then use the *plus* and *minus* buttons to set the display to show the length of cooking time required, eg; 2 hours as shown **(1)**.

After setting, the display will revert to show the time of day, but you can press the *cook time* button and the display will show how much cooking time still remains on the clock.

Press the *ready time* button, and the display will show the actual time the oven is going to switch off - eg; 18.00 (6.00 pm) as shown **(2)**.

At the end of the cooking time, the alarm will sound, and the oven will automatically switch off.

To switch off the alarm, press the *minute minder* button **(3)**.

When the oven has switched off, **return the oven knob to the off position**, and press the *manual* button **(4)**.

If you wish to cancel the automatic setting or to cancel any remaining cooking time left on the clock before the alarm sounds, press the *manual* button **(4)**.

### 1. Auto symbol appears.

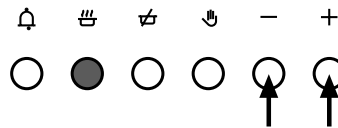

### 2.

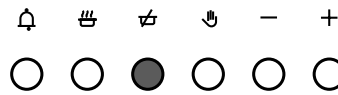

### 3. Auto symbol will flash.

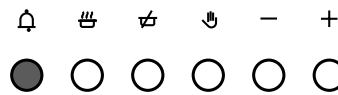

### 4. Auto symbol goes out.

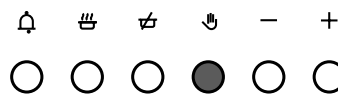

## Programmer / Clock

### Fully automatic cooking (example)

For use when a delayed start time is required.

You want to set the length of cooking time, and the time for the oven to switch off. The programmer will automatically calculate the cooking start time.

Press the *cook time* button, then use the *plus* and *minus* buttons to set the display to show the length of cooking time required - eg; 2 hours as shown **(5)**.

Press the *ready time* button, and the present ready time will be displayed. Using the *plus* and *minus* buttons you can set the display to show the actual time you want the oven to switch off, eg; 18.00 hours (6.00 pm) **(6)**.

The display will revert to show time of day.

**After setting the programmer, turn the oven control to the required temperature.**

The oven will automatically switch on at the calculated start time of 16.00 hours (4.00 pm) **(7)**.

A single press of the *cook time* button shows the cooking time remaining before the oven automatically switches off **(8)**.

5. Auto symbol appears.

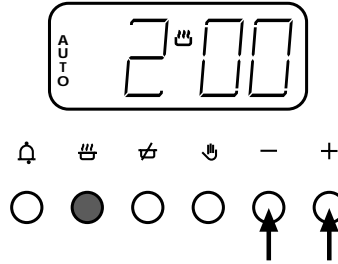

6. The cookpot symbol will disappear from the display.

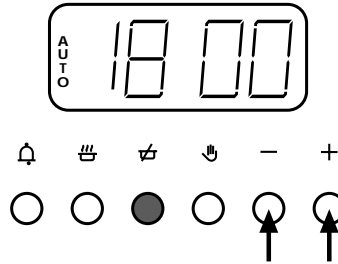

7. The cookpot symbol will appear on the display.

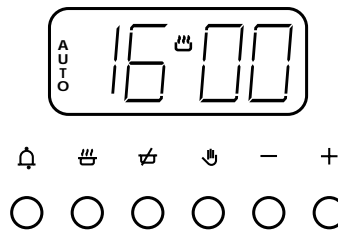

8.

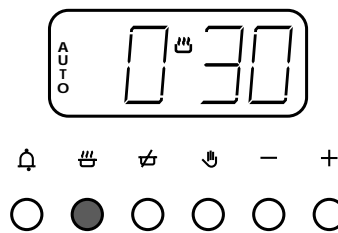

## Programmer / Clock

The oven will automatically switch off at 18.00 hours (6.00 pm) and the alarm will sound **(9)**.

9. Auto symbol will flash.

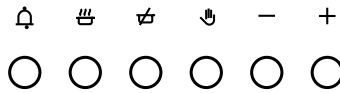

To switch off the alarm press the *minute minder* button **(10)**.

10.

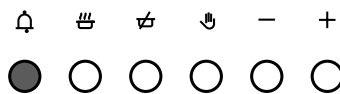
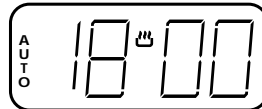

When the oven has switched off, **return the oven knob to the off position**, and press the *manual* button **(11)**.

11. Auto symbol goes out.

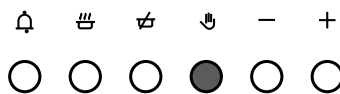

If you wish to cancel the automatic setting before cooking has started, and return to manual operation, press the *manual* button **(11)**. To cancel any remaining cooking time left on the clock before the alarm sounds, press the *manual* button **(11)**.

## Cleaning

**Caution:** Any cleaning agent used incorrectly may damage the appliance.

**Always let the oven cool before cleaning.**

Some cooking operations generate considerable amount of grease, this combined with spillage can become a hazard if allowed to accumulate on the appliance through lack of cleaning. In extreme cases this may amount to misuse of the appliance and could invalidate your guarantee.

It is recommended that the appliance is cleaned after open roasting.

Do not use caustic pastes, abrasive cleaning powders, coarse wire wool or any hard implements, as they will damage the surfaces.

All parts of the oven can be safely cleaned with a cloth wrung out in hot soapy water.

To avoid damaging the surfaces when removing stubborn marks, we recommend the following:

### **Painted, plastic and metal finish parts** (where fitted)

OVEN DOOR, DOOR HANDLE, CONTROL KNOBS

Only use a clean cloth wrung out in hot soapy water.

### **Vitreous enamel parts**

GRILL PAN, OVEN COMPARTMENT FLOOR

Use a mild cream cleaner - eg; "Cif".

Stubborn marks may be removed with a moistened "Brillo" pad.

The grill pan may be cleaned in a dishwasher, or with a nylon brush in hot soapy water.

### **Chrome plated parts**

OVEN SHELVES & OVEN SHELF RUNNERS, GRILL PAN TRIVET

*Do not* use abrasives or polishes. Use a moist soap pad - eg; "Brillo".

Shelf runners can be removed for cleaning. Grasp the runners, and slide out of the hanging holes as shown.

*Note:* These items may also be cleaned in a dishwasher.

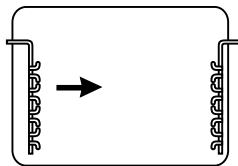

## Cleaning

### Glass parts

#### FACIA PANEL & DOOR PANELS

Use a mild cream cleaner - eg; "Cif". Rinse thoroughly and dry with a soft cloth. Do not use abrasive cleaners or polishes.

To remove the glass panel for cleaning, open the door to the door stop position (about 30° open), hold the top and bottom edges of the panel and slide out. Note that if the door is opened fully when removing the inner door glass panel, the door may spring shut.

**Important:** if the inner door glass panel is removed for cleaning, it must be replaced the right way up as shown, and pushed fully in to the stop position.

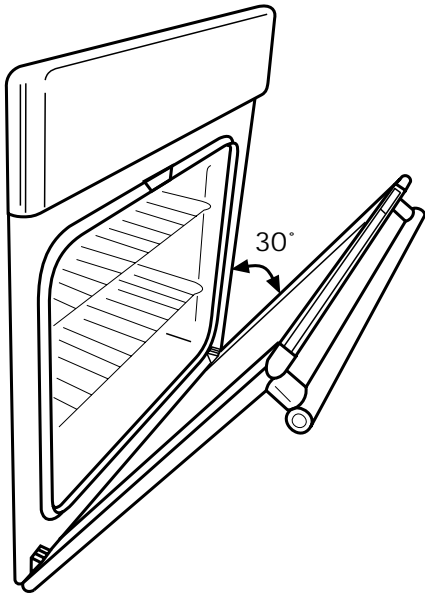

Door stop position

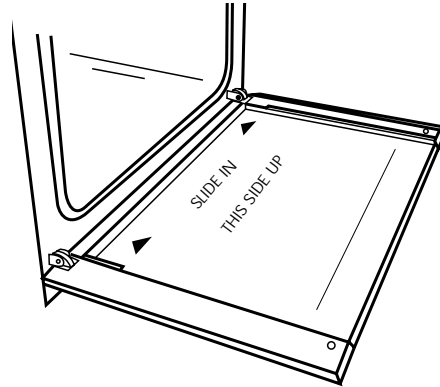

## Cleaning

---

**Stainless steel surfaces** (stainless steel finish models only)

FACIA PANEL, HANDLES

Only use a clean cloth wrung out in hot soapy water, and dry with a soft cloth.

Stubborn marks can be removed using "Luneta". We recommend that you clean the whole of the stainless steel area to maintain a uniform finish. Supplies can be purchased from H.R.P.C. - contact direct sales order line ☎ 01772 819 672.

Do not use undiluted bleach or any products containing chlorides as they can permanently damage the steel.

Extra care should be taken when cooking food in salted water. Some foods are corrosive - eg; vinegar, fruit juices and especially **salt** - they can mark or damage stainless steel if they are left on the surface. Turn off and wipe any spillage immediately, taking care to avoid skin contact with any hot surface or spillage.

Sharp objects can mark the surface of stainless steel, but marks will become less noticeable with time.

To maintain the finish of the stainless steel, or to remove any greasy marks, wipe the stainless steel surface sparingly with a minimum amount of "Johnson's Baby Oil" and kitchen paper. Do not use cooking oils, as these may contain salt, which can damage the stainless steel surface.



## Installation Instructions

### Step 1: Prepare installation

**Do not lift the oven by the door handle.**

Whilst every care is taken to eliminate burrs and raw edges from this appliance, please take care when handling - we recommend the use of protective gloves during installation.

Please note that the weight of this appliance is approximately **27kg** (unpacked). Take care when lifting it into the housing unit - always use an appropriate method of lifting.

If this appliance is to be installed near to a corner where the adjacent cabinets run at right angles forward of the appliance, there must be a gap of at least 90mm between the appliance and the cabinets, to prevent overheating of the cabinets.

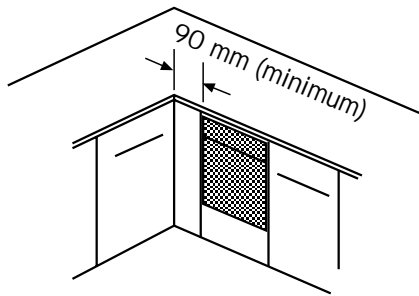

Remove the fixing screws from the polythene bag on the top of the appliance, but leave the appliance in the base tray packaging until you are ready to install it.

*Note:* When removing the appliance from the base tray packaging care should be taken not to damage the appliance.

1. When installing in a typical 600mm deep, built in housing unit, the false back should be removed from the housing unit to provide the necessary depth for installation.
2. When the false back is removed, it is normally the case that the support shelf for the appliance leaves a gap between the back edge and the wall of approximately 80mm.
3. If no gap occurs between the back edge of the shelf and the wall behind the unit, we recommend that a gap of at least 30mm is made by shortening the shelf.

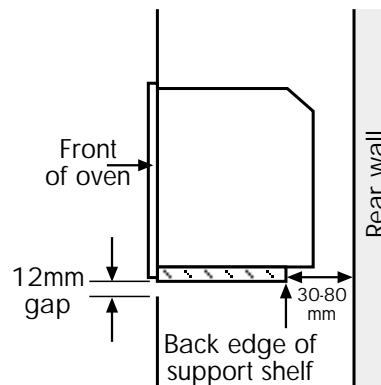

## Installation Instructions

The appliance is designed to fit into a standard 600mm wide housing unit, with **minimum** internal dimensions as shown.

*Note:* **590mm** is to the underside of the worktop when the appliance is built under, or to the underside of the panel above, when the appliance is installed into a tall housing unit.

Please note that all sizes are nominal, and some variation is to be expected.

### Installing appliance under a worktop

Where the appliance is installed under a worktop, with a hob installed above it, the installation instructions for the hob must be read in conjunction with these instructions.

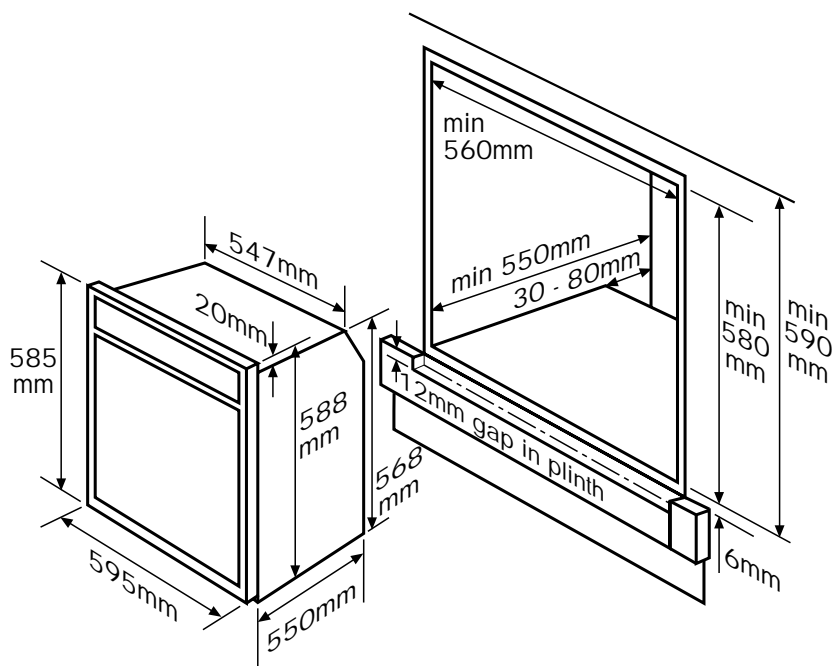

## Installation Instructions

---

### **Step 2: Connect to the electricity supply**

We recommend that the appliance is connected by a qualified electrician, who is a member of the N.I.C.E.I.C. and who will comply with the I.E.E. and local regulations.

**Important:** Ensure that you route all mains electrical cables well clear of any adjacent heat source, such as an oven or grill.

**Warning:** This appliance must be earthed.

1. Where a fixed connection is used, a device allowing the appliance to be isolated on all poles from the mains supply with a contact opening width of at least 3mm must be provided.  
Use a 13 amp fuse.
2. A type HO5 V V-F cable must be used as the mains lead. The cross section must be 2.5mm<sup>2</sup>.
3. The mains terminal block is positioned at the right hand rear of the top service panel.
5. Connect the cable to the terminal block, and tighten the cable clamp.
6. Close the terminal box, ensuring that the cover is engaged on the locking tabs.

## Installation Instructions

### **Step 3: Check edging strip**

The edging strip is factory fitted to the front side edges of the appliance front frame. This strip provides the cabinetry with extra protection from any escape of heat.

When installing the product, ensure that the edging strip is correctly located on the outer edges of the front frame, before positioning and securing the appliance to the cabinet.

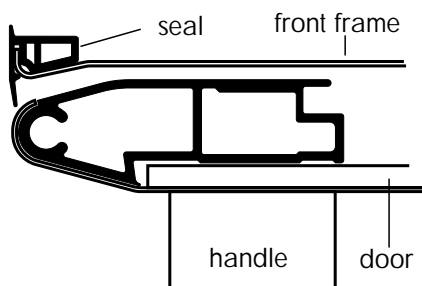

When securing the appliance, the fixing screws provided are driven through the edging strips into the cabinet - the seal will straighten up and sit flush to the cabinet when the screws are fully home.

### **Step 4: Secure appliance into housing unit**

Insert appliance into cabinet.

To secure the appliance to the housing unit, open the oven door and screw 4 screws - 2 at top, 2 at bottom - through the holes in the front frame.

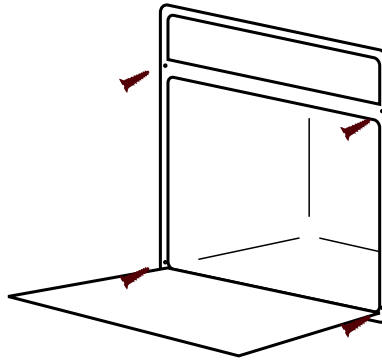

*Note:* The unit housing the appliance must be appropriately fixed.

## Technical Data

---

### Power supply

220 - 240V ~ 50Hz

**Warning:** This appliance must be earthed.

### Element ratings (given at 230V)

Grill	1655W
Fan & Grill	1690W
Fan oven element	2300W
Stir fan	38W
Light	25W
Cooling fan	25W

**Maximum Load** 2390W

## New World Customer Care

---

In case of difficulty within the UK and Northern Ireland, please call the New World Customer Care Centre Helpline on

**0151 432 7838**

When you dial this number you will hear a recorded message and be given a number of options. This indicates that your call has been accepted and is being held in a queue. Calls are answered in strict rotation as our Customer Care Representatives become available.

### Opening Hours for Customer Care Centre

Monday to Friday	8am - 8pm
Saturday	8.30am - 6pm
Sunday	10am - 4pm

Enter appliance numbers here for future reference:

Model No
<input type="text"/> <input type="text"/> <input type="text"/> <input type="text"/> <input type="text"/> <input type="text"/> <input type="text"/> <input type="text"/> <input type="text"/> <input type="text"/> <input type="text"/>
Serial No
<input type="text"/> <input type="text"/> <input type="text"/> <input type="text"/> <input type="text"/> <input type="text"/> <input type="text"/> <input type="text"/> <input type="text"/> <input type="text"/> <input type="text"/>

Please ensure you have the above details (Model No and Serial No) to hand when calling Customer Care. They are essential to booking your call.

Outside the UK and Northern Ireland, refer to your local supplier.

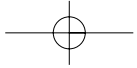
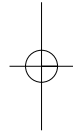
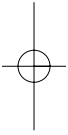



# NEW WORLD

"New World" by Stoves Limited  
Stoney Lane, Prescott, Merseyside L35 2XW

08 24335 03 © 2002